

UANKA®



Líder en
el mercado.

mobiliario
urbano



VANKA, EMPRESA LÍDER EN MOBILIARIO URBANO

Con pasión por la excelencia y la innovación, VANKA es sinónimo de diseño, funcionalidad y calidad en el ámbito del mobiliario urbano.

Estética sofisticada: En VANKA, creemos que el mobiliario urbano debe ser más que funcional, debe ser un elemento estético en los espacios públicos. Nuestros diseños definidos y contemporáneos, fusionan formas orgánicas, líneas limpias y materiales de alta calidad para crear piezas que realzan la estética urbana.

Calidad impecable: En VANKA, la calidad es primordial. Utilizamos los mejores materiales, resistente a la intemperie, hormigón tratado para mayor durabilidad y plásticos reciclables



de alta resistencia, para garantizar que nuestros productos sean duraderos y capaces de soportar las condiciones urbanas más exigentes. Cada pieza se fabrica con precisión y atención al detalle para garantizar una calidad impecable.

Personalización y versatilidad: Reconocemos la importancia de adaptarnos a las necesidades y preferencias únicas de cada ciudad y espacio urbano. Por eso, ofrecemos opciones de personalización y una amplia variedad de productos, desde bancos y papeleras hasta marquesinas y elementos decorativos, que se pueden adaptar para crear soluciones a medida que se integren perfectamente en cualquier entorno.





Banco Pampa



4 personas



450 Kgs



0,42 m x 0,42 m x 2,05 m



Instalación
3 hs



Requiere
grúa

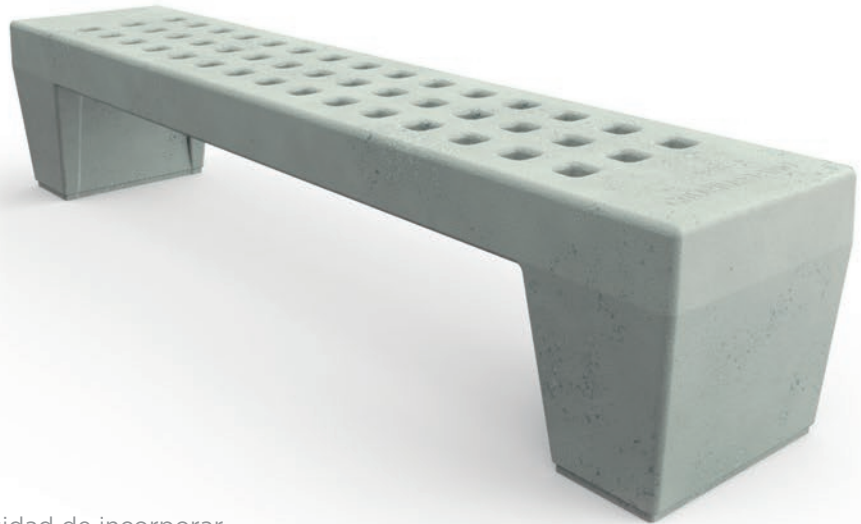

Banco Pampa

El Banco Pampa surge con la necesidad de incorporar un banco visualmente más liviano. De acabados muy cuidados, presenta una textura perforada en el plano superior decorativa y funcional, dado que evita la acumulación de agua.



Material
hormigón armado



Color
natural



Terminación
lisa, bordes redondeados

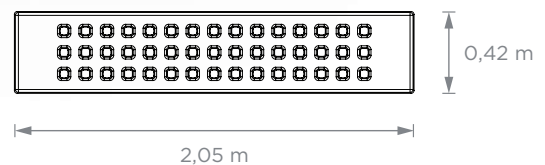
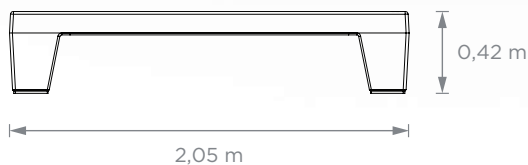
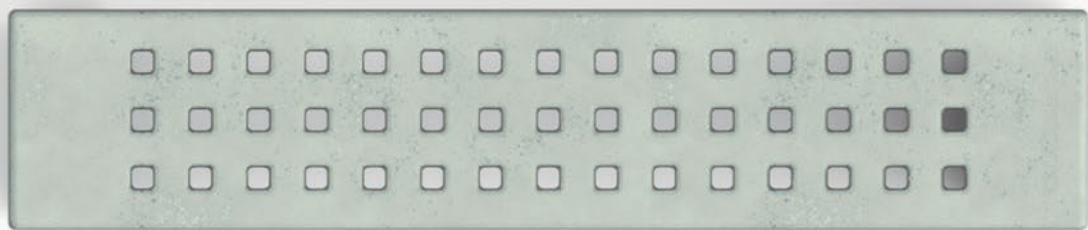
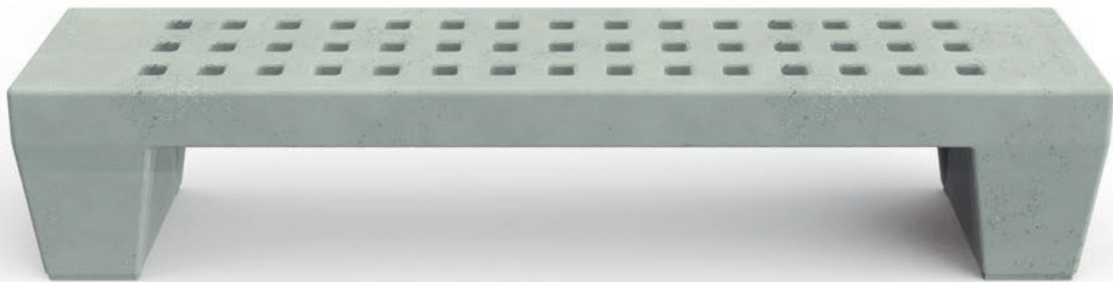

Línea Prisma

La Línea Prisma está integrada por bancos de volúmenes compactos, de geometría pura con un detalle de acabado de estilo clásico. Su geometría neutra permite que se integre fácilmente a los distintos estilos de espacio urbano.

-  Material hormigón armado
-  Color natural
-  Terminación lisa, bordes redondeados



Banco Prisma Chico

 1 persona

 0,42 m x 0,42 m x 0,42 m

 125 Kgs

 Instalación 1,5 hs

 Requiere grúa

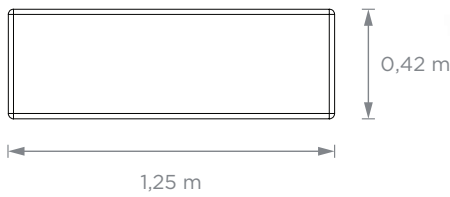
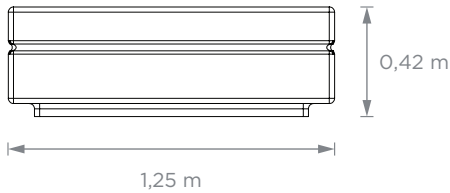
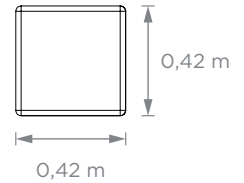
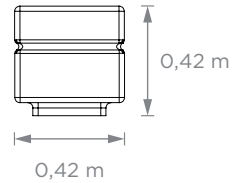

Banco Prisma Mediano

 3 personas

 0,42 m x 0,42 m x 1,25 m

 375 Kgs

 Instalación 2 hs

 Requiere grúa

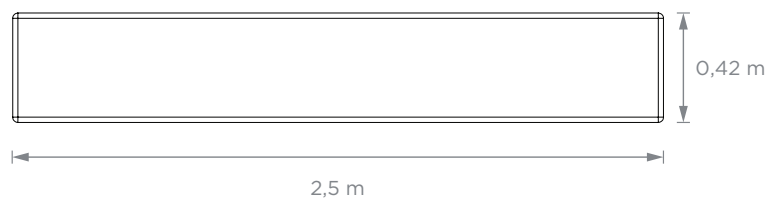
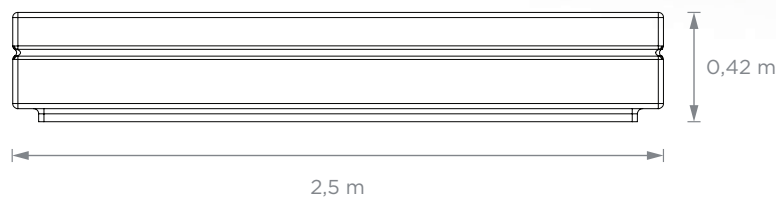

Banco Prisma Grande

 5 personas

 0,42 m x 0,42 m x 2,5 m

 750 Kgs

 Instalación 2 hs

 Requiere grúa

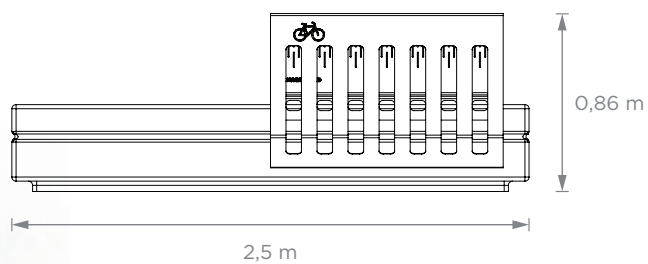
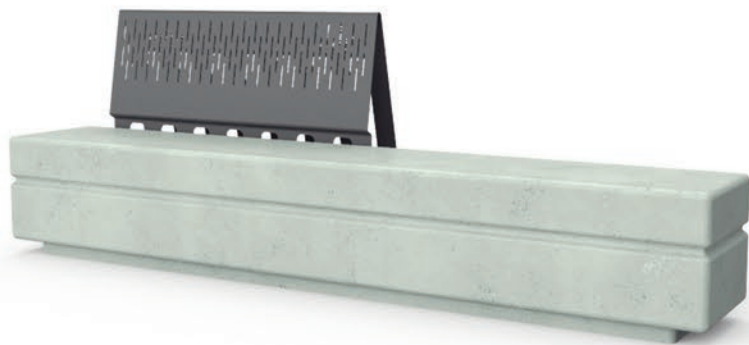

Banco Prisma Grande Bicyclero

 5 personas
7 bicicletas

 0,86 m x 0,62 m x 2,5 m

 780 Kgs  Instalación
2 hs

 Requiere
grúa

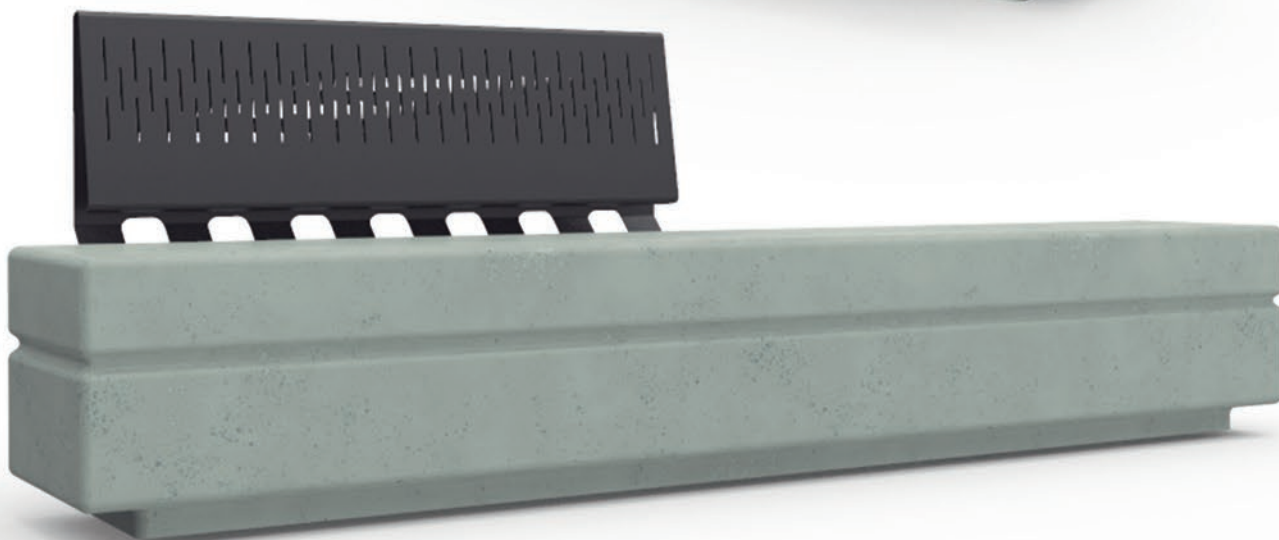
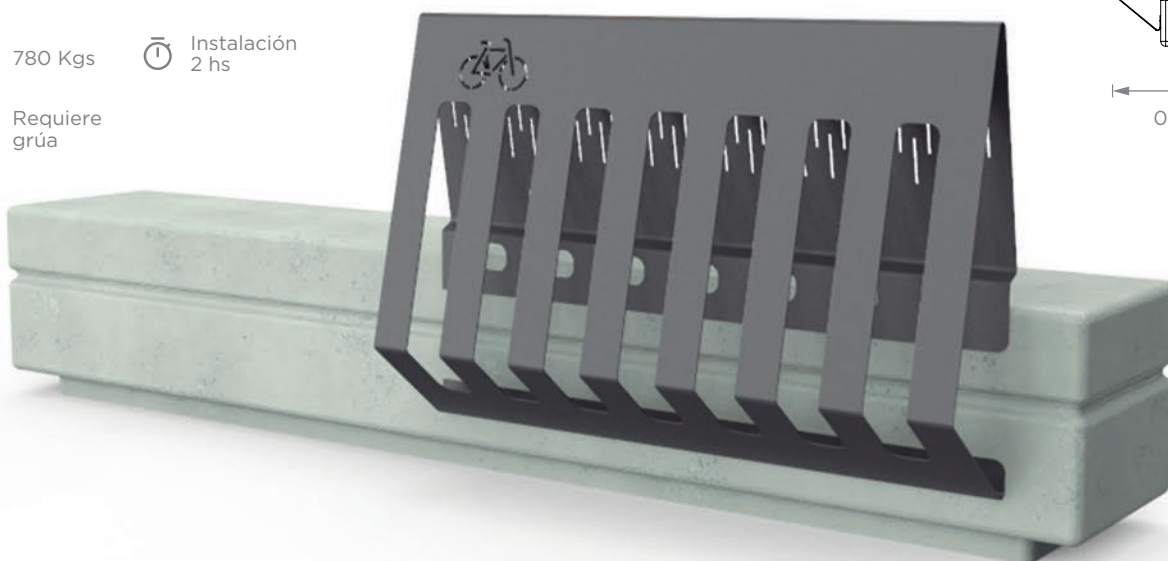
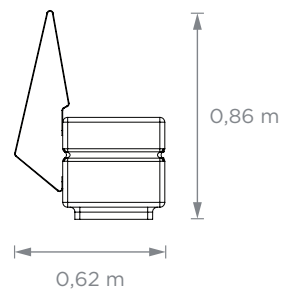

Banco Prisma Grande con Respaldo Simple

 5 personas

 0,86 m x 0,62 m x 2,5 m

 772 Kgs  Instalación
2 hs

 Requiere
grúa

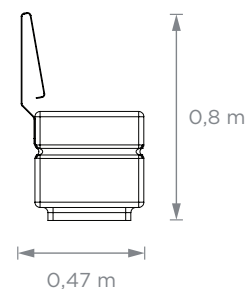
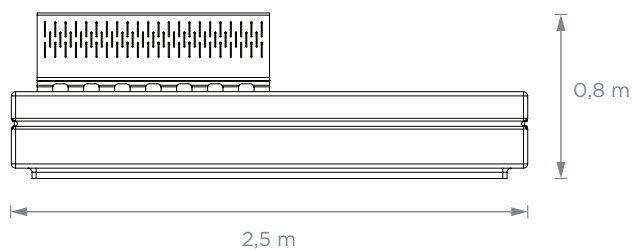





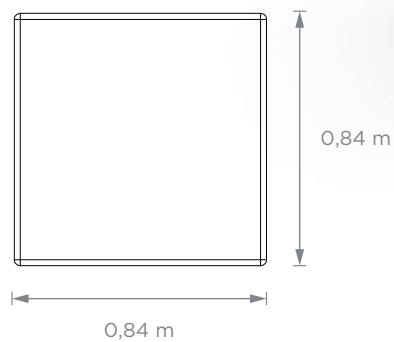
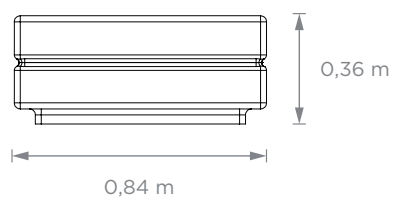

Mesa Baja Prisma



4 personas



0,36 m x 0,84 m x 0,84 m



350 Kgs



Instalación
2 hs



Requiere
grúa



Conjunto Living Prisma



4-6 personas



0,42 m x 2,58 m x 2,58 m



1350 Kgs



Instalación
8 hs



Requiere
grúa

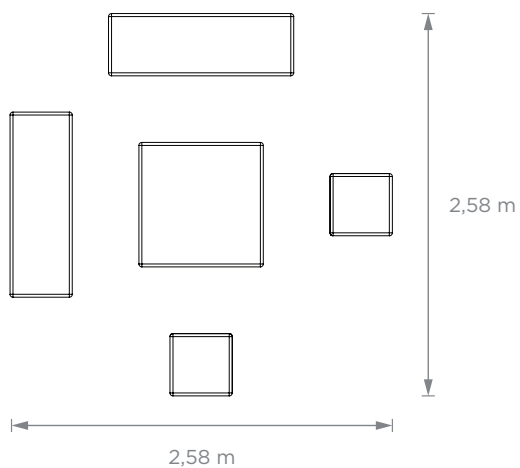

Cesto Prisma

Cesto para el aire libre.

Pieza de hormigón armado de color natural. Terminación lisa, bordes redondeados.

Tapa de chapa de acero. Terminación con pintura poliéster electrostática en polvo termoconvertible, la cual le proporciona protección contra la corrosión y es altamente resistente a impactos y ralladuras.

Producto preparado para empotrar en espacios públicos.

La Línea Prisma posee una geometría pura con un detalle de acabado de estilo clásico. Su geometría neutra permite que se integre fácilmente a los distintos estilos de espacio urbano.

 0,9m x 0,45m x 0,45m

 206,5 kg

 Instalación
2 hs

 Requiere
grúa

 70 Litros

FEBRERO

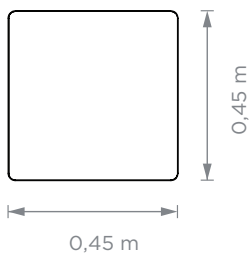
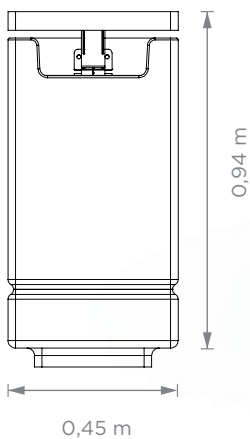

Línea NOA

La Línea NOA invita a la reunión y al juego al aire libre. Es un conjunto de gran presencia, compacto y a su vez elegante. La alternativa de damero, creada en bajo relieve, fue inspirada en el estilo de labrado de vasijas del NOA.



Material hormigón armado



Color natural



Terminación lisa, bordes redondeados



Banco Taburete NOA



1 persona



55 Kgs



0,42 m x 0,28 m x 0,3 m



Instalación 2 hs

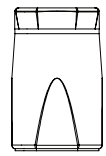

0,42 m

0,28 m

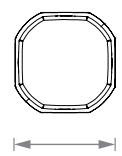

0,28 m

0,28 m

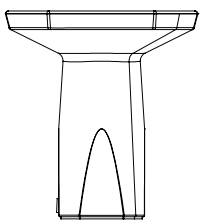

0,75 m

0,69 m

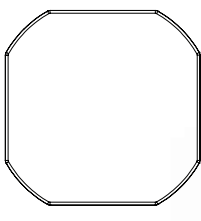

0,69 m

0,69 m



Mesa NOA



4 personas



0,75 m x 0,69 m x 0,69 m



222 Kgs







Instalación 3 hs

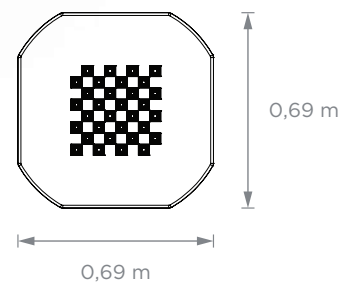
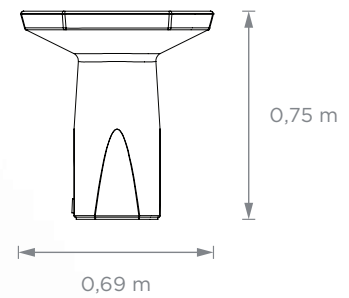

Requiere grúa



Mesa NOA Ajedrez

-  4 personas
 -  222 Kgs
 -  Instalación 3 hs
 -  Requiere grúa
-  0,75 m x 0,69 m x 0,69 m

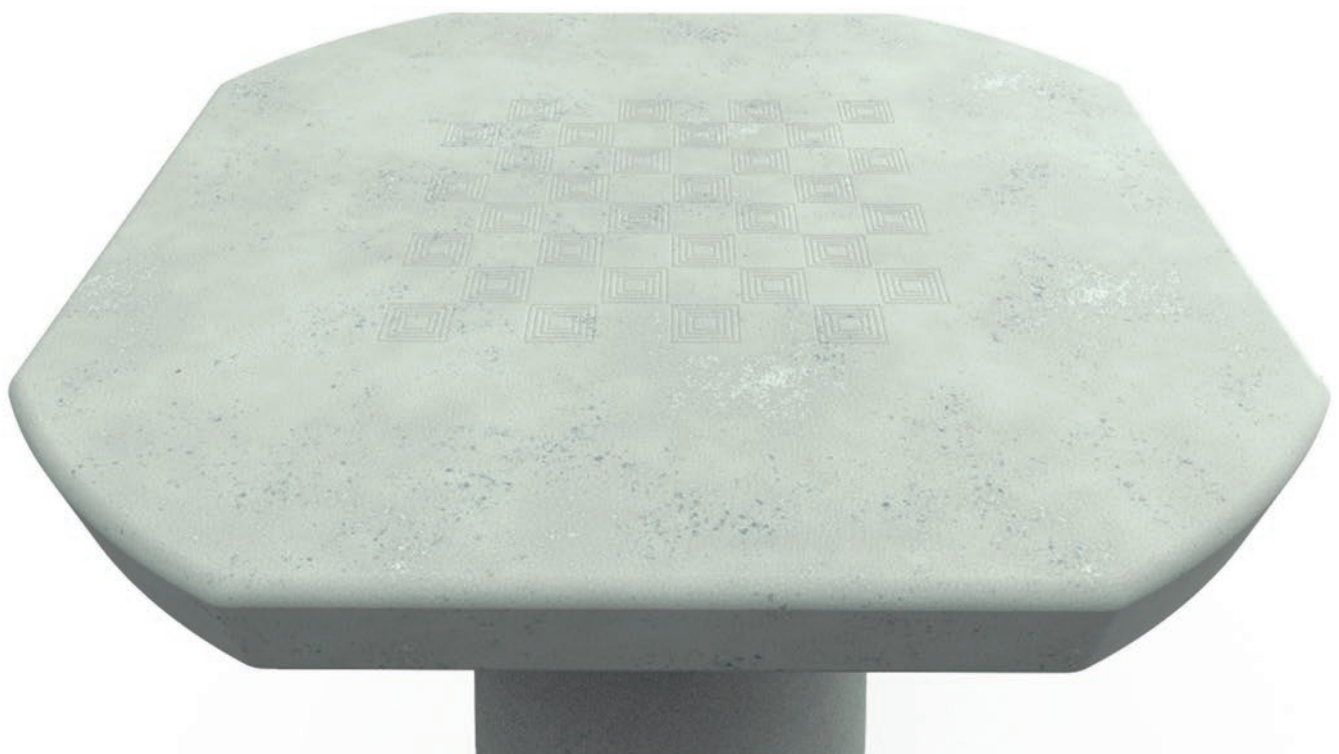

Conjunto Living NOA Ajedrez



4 personas



444 Kgs



Instalación
8 hs



0,75 m x 1,35 m x 1,35 m



Requiere
grúa

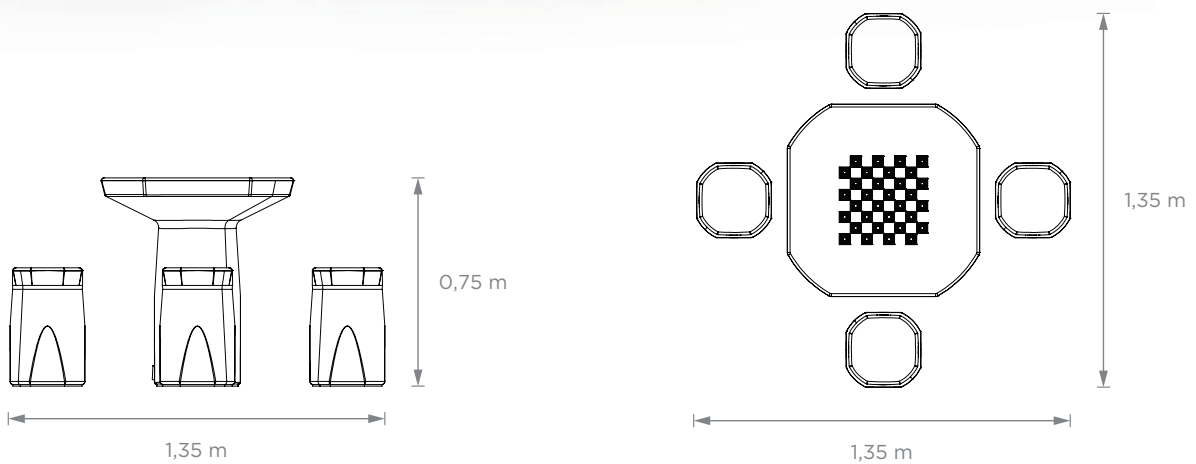

Línea Yembé

La Línea Yembé se compone de Banco taburete y Mesa. Es una repuesta formal simple, liviana, que remite al tradicional instrumento utilizado para diferentes festividades. Brinda un simple espacio de encuentro familiar, de amigos, de rito.

-  Material hormigón armado
-  Color natural
-  Terminación lisa, bordes redondeados

Banco Taburete Yembé

 1 persona  0,43 m x 0,42 m x 0,42 m

 Instalación 2 hs  45 Kgs

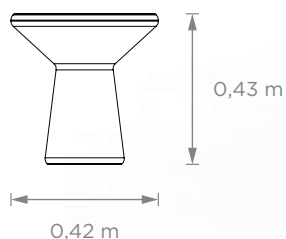

Mesa Yembé

 5 personas  0,75 m x 1 m x 1 m

 350 Kgs  Instalación 3 hs

 Requiere grúa

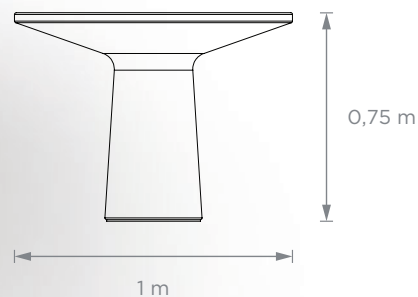

Conjunto Living Yembé

 4 personas  0,75 m x 1,7 m x 1,7 m

 530 Kgs  Instalación
8 hs

 Requiere
grúa

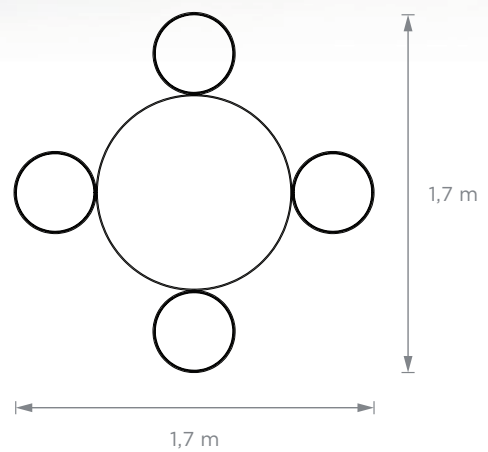
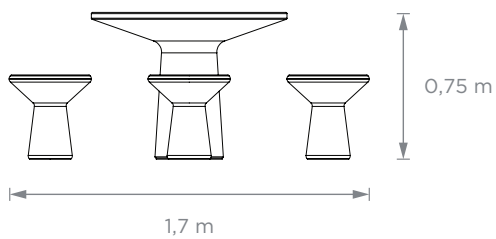

Línea Caliza

La familia de mobiliario Caliza surge de la búsqueda de una respuesta formal distinta, en donde confluyan la vida urbana y la natural. Formalmente inspirada en la estructura de la roca caliza, en su geometría angulosa e irregular, confiere al conjunto la libertad de direccionar el espacio de manera flexible y distendida.



Banco Taburete Caliza

- 1 persona
- 106 Kgs
- Instalación 1 hs
- 0,49 m x 0,42 m x 0,42 m
- Requiere grúa

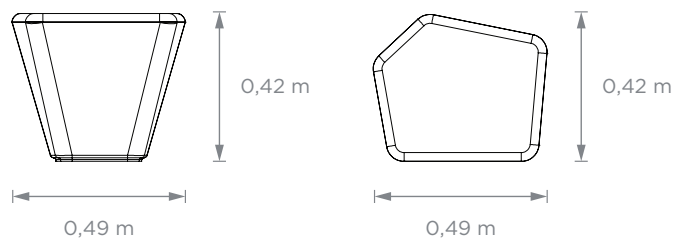

Banco Chico con Respaldo Caliza

- 1 persona
- 1,09 m x 0,99 m x 0,68 m
- 508 Kgs
- Instalación 1 hs
- Requiere grúa

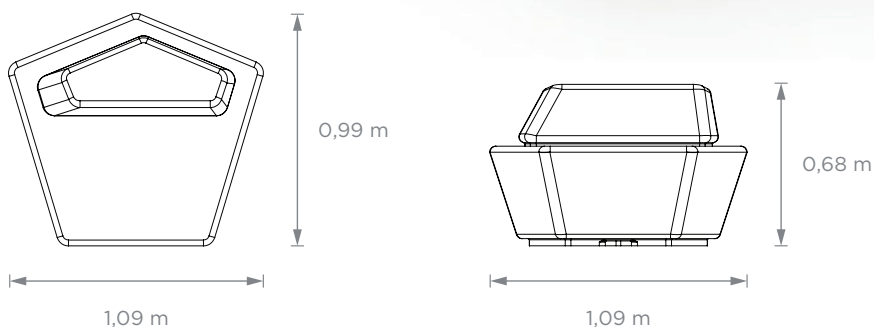



¡NUEVO!

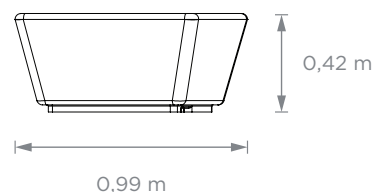
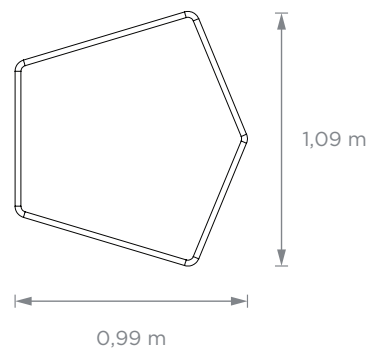

Mesa Baja Caliza

5 personas 0,99 m x 1,09 m x 0,42 m 426 Kgs Instalación 1 hs Requiere grúa

Mesa Alta Caliza

5 personas 202 Kgs Instalación 1 hs
0,88 m x 0,93 m x 1,73 m Requiere grúa



DICIEMBRE

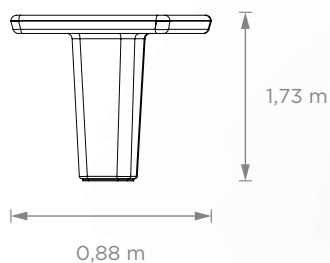
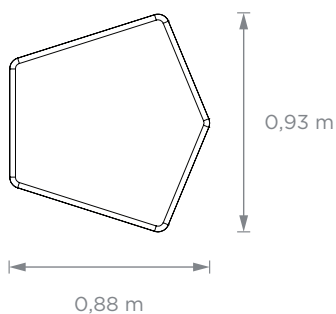

¡NUEVO!



Macetero Caliza

275 Lts Instalación 1 hs 0,99 m x 1,08 m x 0,45 m

Requiere grúa

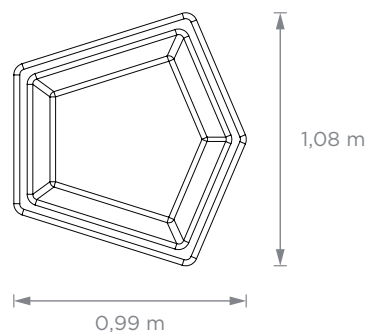
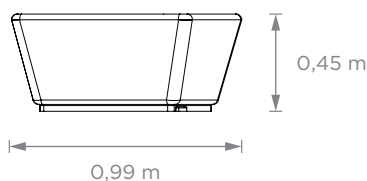



¡NUEVO!

Conjunto Living Mesa Baja Caliza

-  5 personas
-  956 Kgs
-  Instalación 3 hs
-  2,4 m x 2,4 m x 0,42 m
-  Requiere grúa

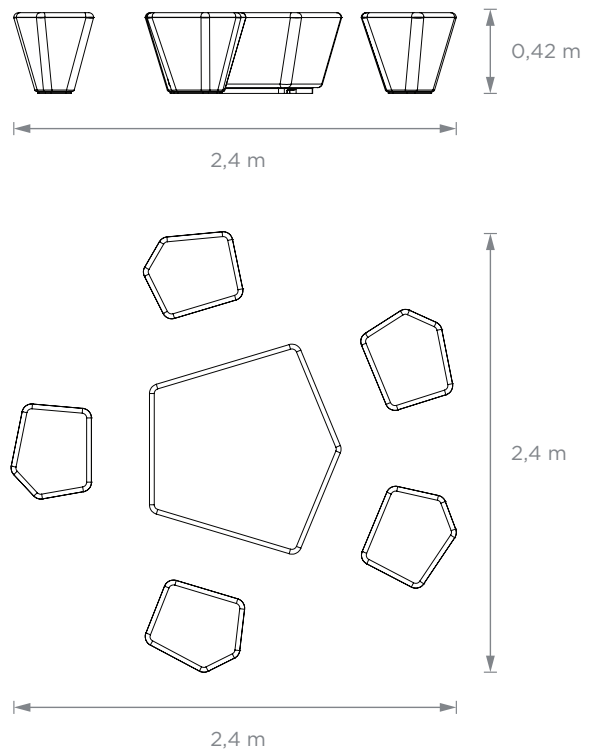

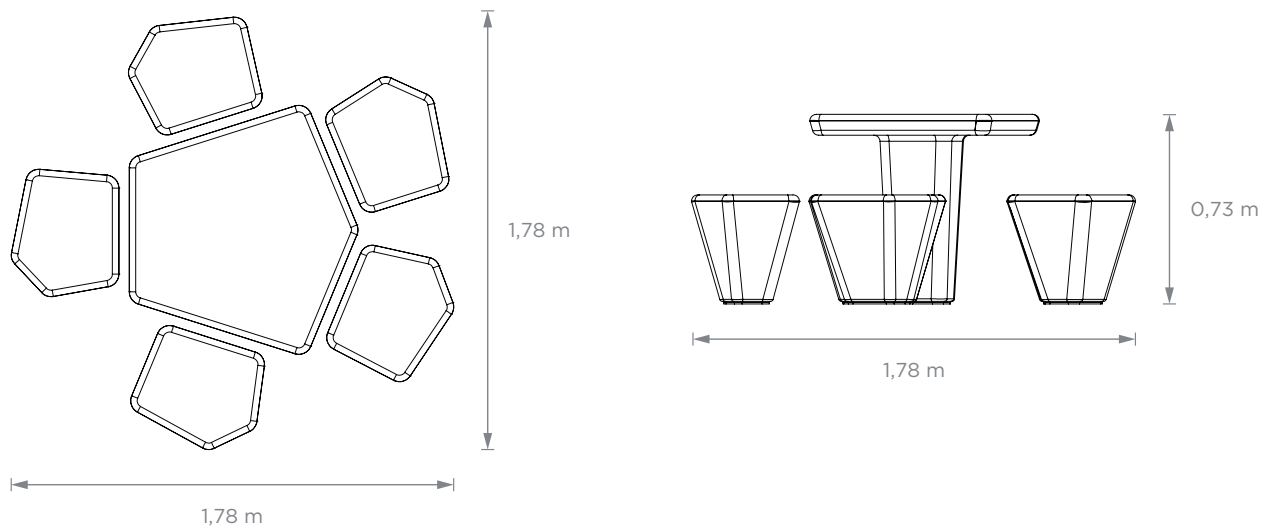



DICIEMBRE



Conjunto Living Mesa Alta Caliza

 5 personas  732 Kgs  Instalación 4 hs

 1,78 m x 1,78 m x 0,73 m  Requiere grúa



Caliza.
Flexibilidad en la organización
del espacio.

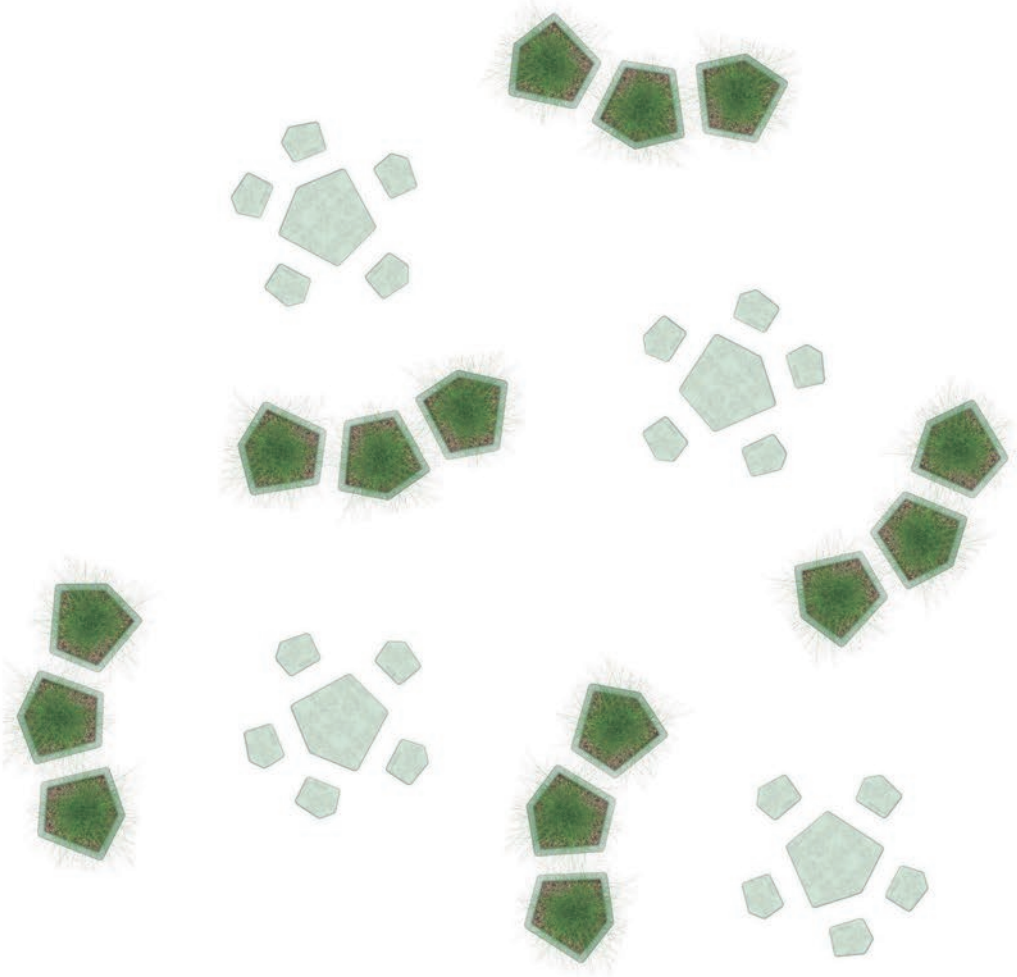

Línea Indra

La Línea Indra está compuesta por volúmenes cilíndricos compactos, de geometría pura con detalles de acabado para asegurar el confort y buena terminación. Su geometría neutra permite que se integre fácilmente a los distintos estilos de espacio urbano.

Las piezas de este conjunto son de hormigón armado, de color natural. Terminación lisa, bordes redondeados. Se encuentran preparadas para empotrar o simplemente apoyar.

-  Material hormigón armado
-  Color natural
-  Terminación lisa, bordes redondeados

¡NUEVO!

Banco Taburete Indra

 1 personas  0,37m x 0,37m x 0,42m

 100 Kgs  Instalación 1 hs

 Requiere grúa

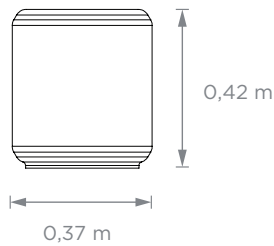

¡NUEVO!

Mesa Baja Indra

 4 personas  0,36m x 0,8m x 0,8m

 310 Kgs  Instalación 1 hs

 Requiere grúa

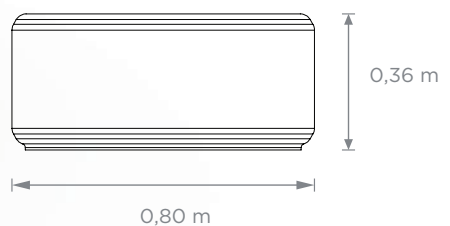

Conjunto Mesa Baja Indra

4 personas 0,42m x 2,34m x 2,34m

730 Kgs Instalación 3 hs

Requiere grúa

¡NUEVO!

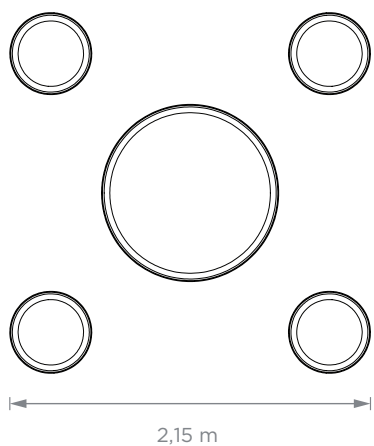

Mesa Alta Indra

Mesa alta para el aire libre.

Pieza de hormigón armado de color natural. Terminación lisa, bordes redondeados.

Producto preparado para empotrar en espacios públicos.

La Línea Indra está compuesta por volúmenes cilíndricos compactos, de geometría pura con detalles de acabado para asegurar el confort y buena terminación. Su geometría neutra permite que se integre fácilmente a los distintos estilos de espacio urbano.

 4 personas  0,72m x 0,88m x 0,88m

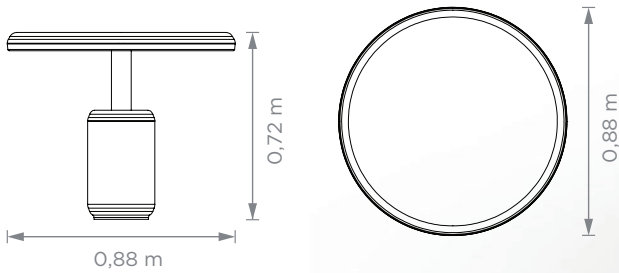

 145 Kgs  Instalación 1 hs

 Requiere grúa



FEBRERO

Conjunto Mesa Alta Indra

 4 personas  0,42m x 2,34m x 2,34m

 730 Kgs  Instalación 3 hs

 Requiere grúa

FEBRERO

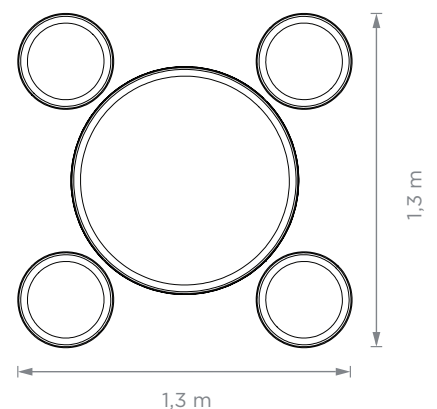
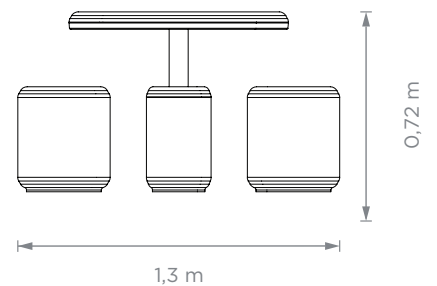

Bancos Comunitarios

Bancos para espacios abiertos con respaldo y asiento de Madera de Eucaliptus grandis laminada, con tecnología de apoyo con pefileria de acero con terminación poliester termoconvertible.

Banco Comunitario con respaldo 1x4

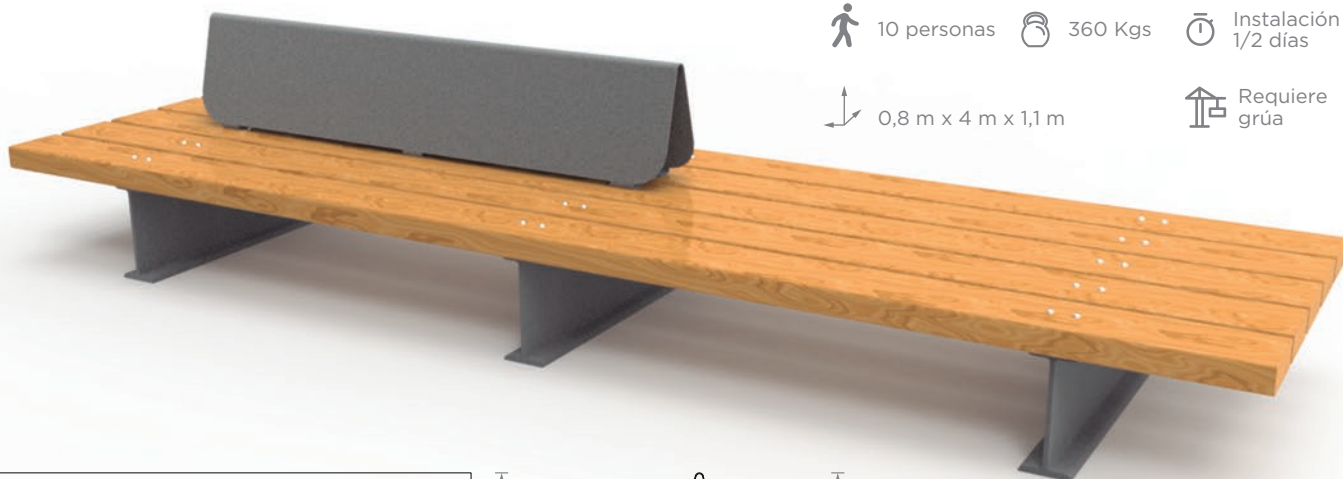

- 10 personas
 360 Kgs
 Instalación 1/2 días
- 0,8 m x 4 m x 1,1 m
 Requiere grúa

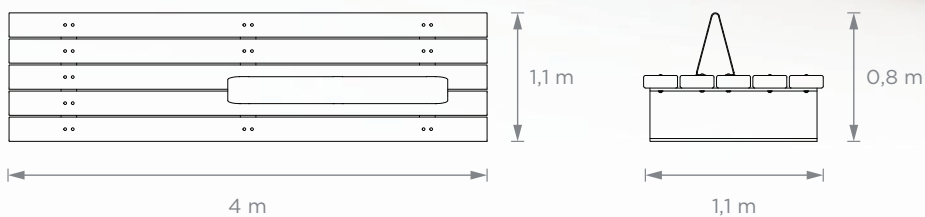

Banco Comunitario con respaldo 2x2

- 8 personas
 365 Kgs
 Instalación 1/2 días
- 2 m x 2 m x 0,8 m
 Requiere grúa

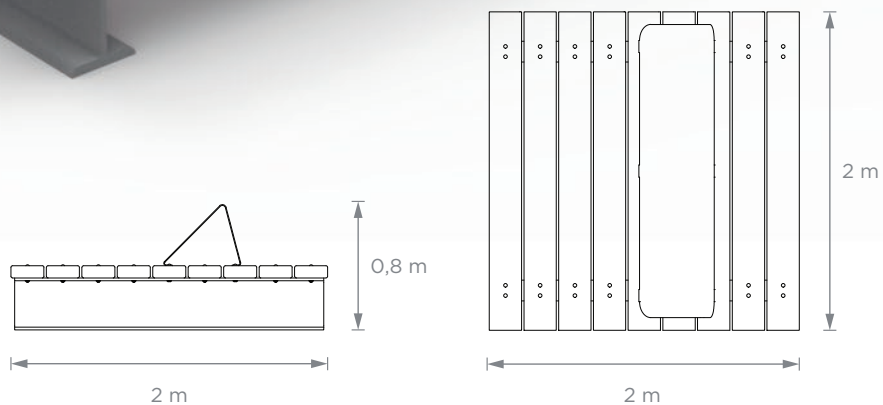

Banco Cintac

Banco de plaza con soportes metalicos y banca de tablonos de PLASTICO RECICLADO simil madera. Diseñado para espacios públicos. La gama de colores de los tablonos puede variar segun el stock, dentro de los cremas marrones.



Banco Cintac

 4 personas  0,48 m x 0,5 m x 1,7 m

 47 Kgs  Instalación 2 hs

 Requiere grúa

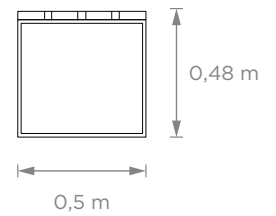
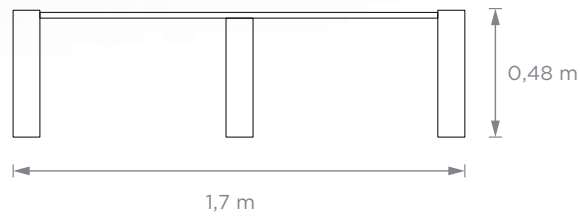

Banco Cintac con respaldo

 4 personas  0,9 m x 0,5 m x 1,7 m

 66 Kgs  Instalación 2 hs

 Requiere grúa

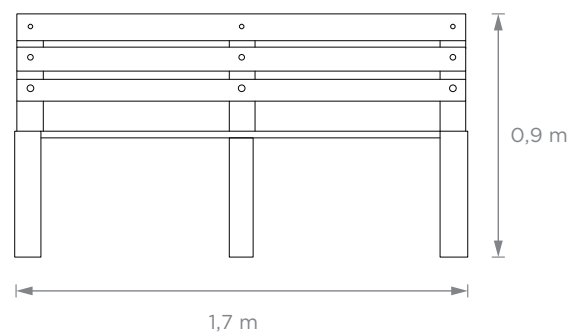
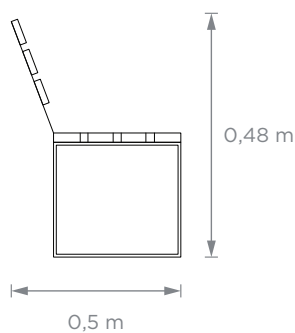



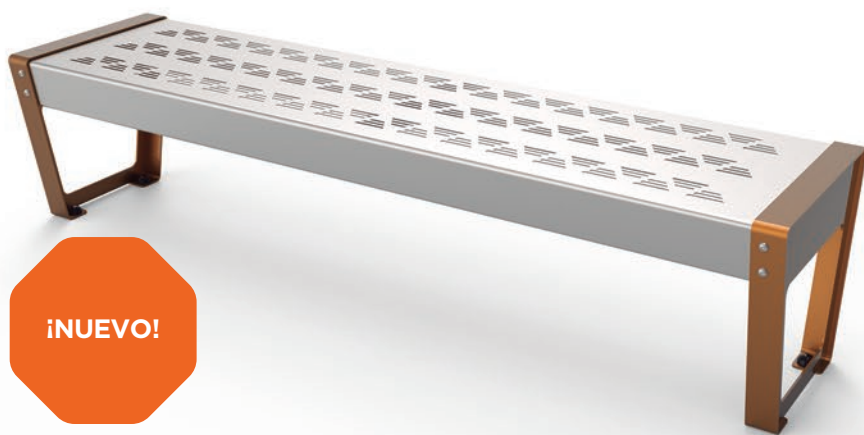

Línea Trapez

Es una línea de diseño de gran presencia, compacto y a su vez elegante.

Las piezas de este conjunto son de chapa plegada. Terminación con pintura poliéster electrostática en polvo termoconvertible. Los elementos se encuentran preparados para empotrar o simplemente apoyar.



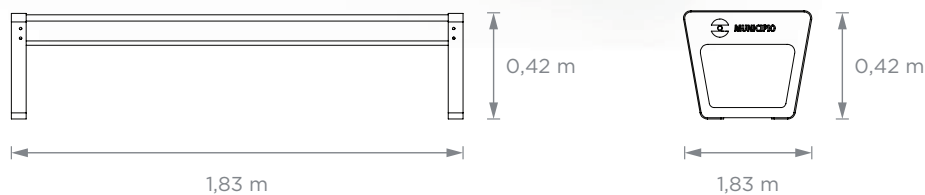

Banco Trapez sin respaldo

-  3 personas
-  0,42 m x 0,51 m x 1,83 m
-  36 Kgs
-  Instalación 30 min
-  No requiere grúa



Banco Trapez con respaldo

-  3 personas
-  0,87 m x 0,61 m x 1,83 m
-  55 Kgs
-  Instalación 1 hs
-  No requiere grúa

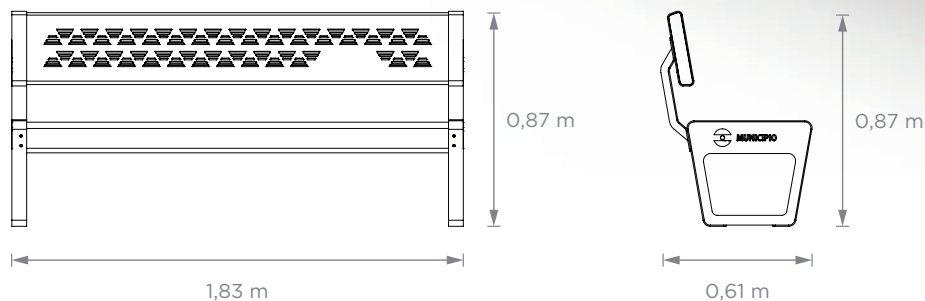

¡NUEVO!

¡NUEVO!



Macetero Trapez

↑ 0,86 m x 0,62 m x 2,5 m

⚖ 6 Kgs

🕒 Instalación
30 mins

🏗 No requiere
grúa

Cesto Trapez

↑ 0,85 m x 0,42 m x 0,5 m

⚖ 51 Kgs

🕒 Instalación
30 mins

🏗 No requiere
grúa



Conjunto Trapez

Cesto Ayla

Cesto diseñado a partir de una morfología neutra con detalles delicados, lo cual permite que se acople perfectamente con los diferentes estilos de espacio urbano. Compuesto por piezas de chapa plegada. Terminación con pintura poliéster electroestática en polvo termoconvertible.

Producto preparado para empotrar en espacios públicos.

 1,15m x 0,4m x 0,3m

 206.5 kg

 Instalación
30 min.

 70 Litros

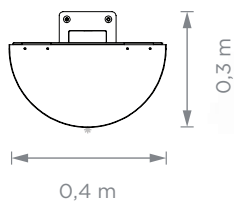
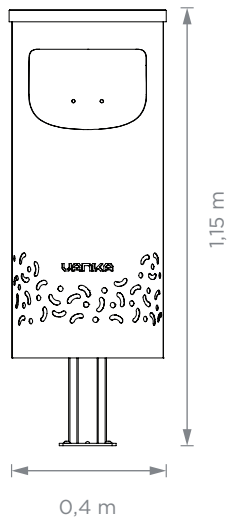

¡NUEVO!





Bicicletero Merckx

↗ 0,8 m x 0,12 m x 0,15 m

🏋️ 10 Kgs

🕒 Instalación 60 min

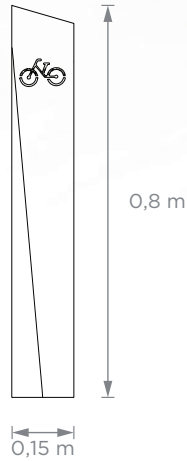

Bicicletero Longo

↗ 0,85 m x 0,7 m x 0,2 m

🏋️ 25 Kgs

🕒 Instalación 2 hs

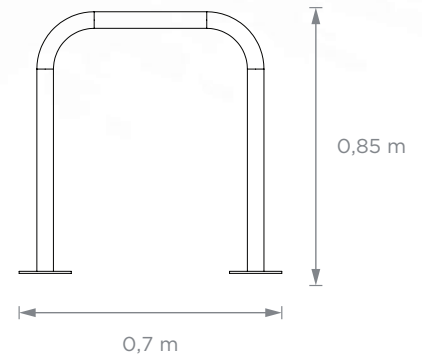

Bolardos

Los bolardos sirven de obstáculo para impedir el paso o estacionamiento de vehículos en los espacios públicos pacíficos.

- 🏗️ Material hormigón armado
- 🎨 Color natural
- ★ Terminación lisa, bordes redondeados



Arita

↗ 0,51 m x 0,3 m x 0,3 m

🏋️ 57,5 Kgs

🕒 Instalación 2 hs

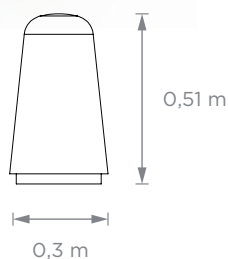

Auca

↗ 0,45 m x 0,3 m x 0,3 m

🏋️ 62 Kgs

🕒 Instalación 2 hs

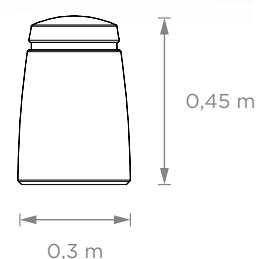

Bolardos Ischi

Los bolardos Ischi, no sólo sirven de barrera vehicular sino que invitan al descanso lúdico, al juego.

Gestados en base al concepto de ciudad jugable e inspirados en el paisaje de Ischigualasto.

Ischi 400

Ischi 500

**Ischi 900
Semiesfera**

**Ischi 500
Semiesfera**

**Ischi 500
Semiesfera**



0,37 x 0,4 x 0,4m

0,47 x 0,5 x 0,5m

0,45 x 0,9 x 0,9m

0,25 x 0,5 x 0,5m

0,20 x 0,4 x 0,4m

78 Kgs

155 Kgs

458 Kgs

77 Kgs

78 Kgs

Instalación
1 hs

Instalación
1 hs

Instalación
1 hs

Instalación
1 hs

Instalación
1 hs

Requiere
grúa

Requiere
grúa

Requiere
grúa

Requiere
grúa

Requiere
grúa

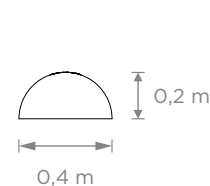
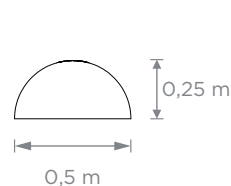
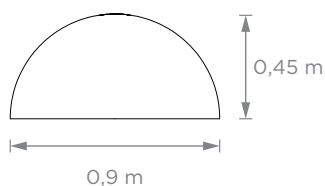
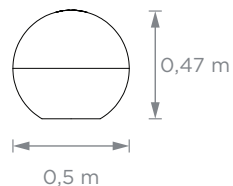
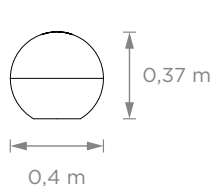

Transformamos Espacios

Ezeiza 1631 - Rosario, Santa Fe. Argentina.

Tel: +54 9 341 528 2002

 vanka.mobiliariourbano



Última fecha de revisión: Noviembre de 2023

